



HAL
open science

Velars and empty-headedness in Government Phonology

Daniel Huber

► **To cite this version:**

Daniel Huber. Velars and empty-headedness in Government Phonology. *Rivista di Grammatica Generativa*, 2003, 28, pp.45-56. hal-00979911

HAL Id: hal-00979911

<https://hal-univ-tlse2.archives-ouvertes.fr/hal-00979911>

Submitted on 17 Apr 2014

HAL is a multi-disciplinary open access archive for the deposit and dissemination of scientific research documents, whether they are published or not. The documents may come from teaching and research institutions in France or abroad, or from public or private research centers.

L'archive ouverte pluridisciplinaire **HAL**, est destinée au dépôt et à la diffusion de documents scientifiques de niveau recherche, publiés ou non, émanant des établissements d'enseignement et de recherche français ou étrangers, des laboratoires publics ou privés.

VELARS AND EMPTY-HEADEDNESS IN GOVERNMENT PHONOLOGY

Dániel HUBER

0. Introduction

In government and licensing theories velars are usually considered to be headless consonants, that is, headed by the “empty element” \cong (*cf* Kaye–Lowenstamm–Vergnaud 1990, Charette 1992, Harris 1997, Cyran 1997, see especially Harris and Lindsey 1995; Scheer 1998, for instance, argues for coronals being placeless). Making velars and empty nuclei akin is a claim that has, even if realized, not been particularly well worked out in the literature, although it definitely contributed to steering phonologists clear of velars in general. The empty element is problematic in itself for a number of practical and theoretical reasons, pulling velars with it. It will be argued here that the velars–empty elements connection is a promising line of thinking, but a number of adjustments is needed to correctly interpret that connection. This paper reviews the status of \cong as well as the problems it raises with respect to velars, and it will be argued that the empty element \cong is not in fact a necessary term in the element inventory and that it is not part of the make-up of velar segments (nor of any other segment for that matter). This will also lead, following Backley’s line of thinking, to the reconsideration of heads and headedness in velars as well: a mechanism of *tier activation* will be introduced. The ultimate conclusion is that velars only refer to the place elements *I* and *U* for phonological operations, that is, these only can be evoked on occasion, while any other independent velar place element is superfluous. It is important to point out that “placelessness” means *the lack of an independently motivated place element* which would uniquely identify velars.

After a brief history of the evolution of autosegmental approaches and their characteristics, the notion of heads will be looked at more closely. Following Backley (1995) and Backley – Takahashi (1998), heads will be eventually done away with in favour of a more constrained theoretical mechanism: *tier activation*. This step rather closely affects velars and a reconsideration of their behaviour and their make-up will have to be done.

1. Velars in feature theory

Feature theory does not recognize a feature [+/-velar] in its inventory in the first place. While in the classification of DF's [coronal] is found among primary stricture features and [labial] also figures as a lip-attitude feature, no feature makes reference to [velar]. Velars are marked [-coronal] and [-labial], which does seem to suggest that they lack a phonologically relevant place of articulation for which they could be specified positively even in feature-based analyses. It has to be noted that velars are positively marked for [high], a place feature indeed, but this feature is different in as much as it does not define an exact place in the oral cavity, whereas [coronal] and [labial] uniquely select the tongue blade and the lips for their execution.

This specification brings out some remarkable properties of velars. First of all, velars on the one hand share [-coronal] with labials, uvulars and pharyngeals. In fact, "[–coronal] sounds are defined negatively – *ie* as involving the absence of a raising of the tongue blade" (Durand 1990:63). The feature [labial], on the other hand, is not part of the SPE inventory proper, but Durand argues that it is needed as distinct from [round] once a number of rules become simpler and more natural to explain. The feature [labial] stands for *constriction* at the lips as opposed to the *protrusion* of the lips associated with [round]. They must be kept apart. As an example, Durand cites (p 49) a rule from Finnish where a voiced velar fricative becomes a labial fricative [v] between high round vowels (/u/ and /ü/):

$$(1) \otimes \rightarrow v / \begin{array}{ccc} [+high] & \text{---} & [+high] \\ [+round] & & [+round] \end{array}$$

Durand rightly argues that in this rule the actual change does not receive a natural explanation since why should a velar become labial exactly between high round vowels – unless there is some more intimate connection between them. With [labial] instead of [round], however, the change boils down to a simple case of assimilation:

$$(2) \frac{\begin{array}{ccc} [+high] & \rightarrow & [+labial] / [+high] \text{ ---} [+high] \\ [+back] & & [+labial] \quad [+labial] \end{array}}{\begin{array}{c} [+continuant] \\ [+voice] \end{array}}$$

Two further points of connection between velars and other classes of sounds have to be mentioned briefly. One of them is the feature [anterior], the other primary stricture feature besides [coronal]. Velars share a negative setting for this feature with palato-alveolars and palatals on the one hand, and uvulars and pharyngeals on the other. It is then not due to coincidence that velars often develop to [+coronal]

palato-alveolars/palatals. Again, such processes are suggested to be a straight-forward case of assimilation in the feature [coronal] (and [high]). The other feature, [grave], marks labials and velars (as well as back rounded vowels) positively specified. In establishing this feature, one of the main pieces of support was the recognition that well-attested phenomena that relate labials and velars are rather difficult to explain with articulatory, that is, “production” features: “For what affinity is there between the lip gesture which defines labials and the raising of the back of the tongue towards the velum which defines velars?” (Durand 1990:63).

A remark is in order at this point. The fact that velars lack a phonologically relevant place of articulation does not mean, of course, that they are not articulated at some place. Obviously they are produced with the tongue raised against the velum, accompanied by laryngeal and resonance activity as required. But it seems to be the case that they lack a place of articulation which could be relevant *phonologically*. In other words, no phonological rule can make reference to a velar place. It can be said then that what sets velars apart from segments which are produced at a labial and a coronal place of articulation is that velars are not produced at either of these places.

2. Element theories (1) – featuring heads, as in Harris and Lindsey (1995) and Cyran (1997)

Harris and Lindsey (1995) argue for an elemental make-up of phonological representations in place of the mainstream feature-based (SPE) approach. The main characteristics of such an element-based framework are the following (without detailed support here):

- (3) (i) the autonomous interpretation hypothesis (direct interpretability and perceptibility of elements);
- (ii) monovalency (privativity as opposed to binary features: an element is either present or not, and no rule can refer to the absence of an element);
- (iii) there is a direct relationship between the process and the environment in which it occurs.

The authors take the following elements to be the phonological primes in element theory:

- (4) “classical” element inventory:
 - A* lowness
 - I* frontness, palatality
 - U* roundness, labiality
 - R* element for coronality (?)
 - h* for “noise” (friction)

? for “occlusion” (stopness)
H voicelessness
L voicedness
N nasality
 \cong emptiness, the canvass element

To express differences in element weightings in compound expressions (where the same elemental composition is given, yet one of them is more prominent), they introduce the notion of *headedness* marked by underlining. To account for ATR-differences in the vowel inventory, they further argue for a *canvass-element* which underlies each and every segment, but contributes to the realization only when in head-position: in other words, non-ATR vowels contain an active, rather than a recessive, empty element. This is illustrated below:

(5) /i/ = {I, (\cong)} ATR /I/ = {I, \cong } non-ATR
 /e/ = {A, I, (\cong)} /E/ = {A, I, \cong } / Θ / = {A, I, (\cong)}

In their article, Harris and Lindsey also make specific claims as for the expression of velars. “Vocalization of velars (...) typically results in reduction to zero, sometimes via \otimes . This development is not unexpected, given the assumption that velar resonance is associated with the element [\cong]” (Harris and Lindsey 1995:67). More specifically, they add (*ibid*): “Independently, [\cong] manifests itself as *approximant* \otimes (non-syllabic ∞), but the lack of an active resonance component in this element is predicted to make it particularly likely to be eclipsed when not supported by other elementary material” [*italics mine*].

By virtue of the fact that velars are headed by \cong , the voiced velar fricative [\otimes] will be the consonantal counterpart of the headless vowel segment [∞], which also only contains the \cong element as head. These two sound segments do not contain, it is claimed, any elements whatsoever, the difference between [\otimes] and [∞] is much the same as that between /i/ and /j/ or /u/ and /w/, it is merely the position they occupy in the skeleton: the fricative (approximant ?) fills in a consonantal slot, while schwa (or one of its kins) is found in a vowel slot. The further differentiations among velars fall out then as follows:

(6) [i/j] = [I]
 [u/w] = [U]
 [\otimes] = { \cong }
 [x] = {h, \cong }
 [g] = {?, L, \cong } possibly with {h} added for aspiration where relevant
 [k] = {?, H, \cong } possibly with {h} added for aspiration where relevant
etc

Although views differ widely also with respect to the status and role of *h* and *H*, what is of significance here is that the place-defining elements (I, U and A) are all missing, only the institutionalized empty element is around. From this it can be concluded that velars can afford to lack a place of articulation phonologically.

The problem around velars in these *element(al)* approaches is really the status and interpretation of \emptyset . The possibility of relating $[\emptyset]$ and schwa, however, is a promising step towards looking at velars from a new perspective. Harris and Lindsey (1995:60) argue that \emptyset is a canvass element onto which all other “colours” can be painted to mix various vowels. Unless some other paint, such as A, I or U, has been carried on it, it will surface as $[\omega/\leftrightarrow]$ or some other reduced segment. In much the same vein, it can be argued that $[\emptyset]$ undergoes much the same fate under a consonantal slot. They also argue that \emptyset is present in all vowels, which is seen when under phonological circumstances “fleshy” vowels are reduced to $[\emptyset]$. There is a slightly different approach to these reductions, though.

Theories analyzing lenition phenomena offer an alternative. In these theories, sound alternations (as well as changes) are analyzed as elemental simplification or composition under certain phonological circumstances. In such a theory, to simplify a little, a consonantal alternation, for instance, between a stop and its corresponding fricative is the result of the suppression of the stop element \emptyset . This element does not disappear altogether, without trace, but it is suppressed – for the more visually inclined: it gets between angled brackets $\langle \emptyset \rangle$. In this theory the reduction of a vowel to schwa will also be the result of one or more of the three elements getting between angled brackets: $\langle A \rangle$ or $\langle I \rangle$ or $\langle U \rangle$. When there is no alternation between a full vowel and $[\leftrightarrow]$, and only $[\leftrightarrow]$ surfaces, then any or all of the three can be posited to underlie the representation depending on the system in question. In much the same manner it can be argued that in $[\emptyset]$ all elements are suppressed. To account for the other velars, consecutively more elements are licensed. This line of thinking leads essentially to that advanced by Backley (1995). There will be, though, a number of modifications to his account which will ultimately make bracketings unnecessary. The advantage of *his* analysis is that there is no need to recourse to empty elements either. Moreover, the question of headedness is also resolved.

A further problem of representing the empty element is rather overt when it is taken into account that the elements are assumed by Harris and Lindsey to occupy their own lines or melodic tiers. Something which is not there is hard to imagine to occupy any tier of its own, although a redundant tier might be assumed. If, however, no reference is actually made to that line, it is better to do away with it altogether: why keep a construct when it is never used? This is seen as a welcome step towards eliminating empty elements from representations. In Cyran (1997:193), for instance, a plain velar stop receives the expression below as opposed to $/p/$ and $/t/$:

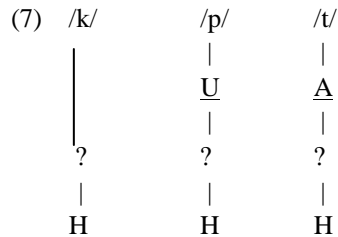

The difference between /p, t/ and /k/ is carried by the lack of any place element in the representation of the velar. The concept that velars are empty-headed, or rather downright headless, is still observed since there is really no head underlined in the expression of /k/. Such a representation is advantageous because it can cope with velar phenomena observed in the world's languages. When a velar palatalizes to an affricate, a segment containing the element I, is easily incorporated into the representation creating a contour structure, as shown in Cyran (1997:212; here he has *h* originally, but they have been replaced uniformly with *H*):

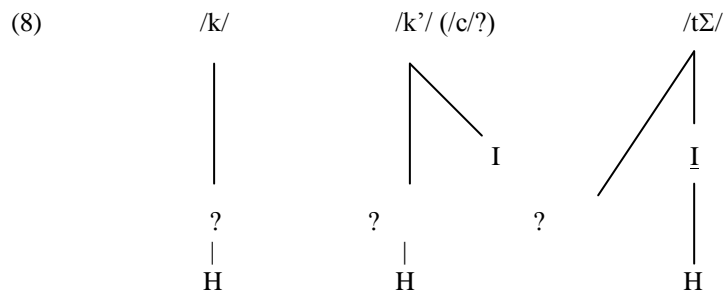

However, the need to accommodate an U element in labio-velars also requires an U in some position. One possibility is to represent labio-velars as unheaded contour segments and not a single vertical structure:

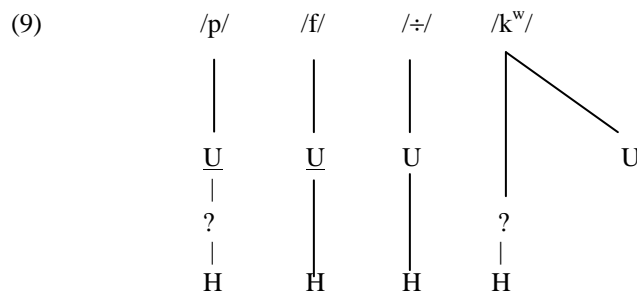

The advantage of representing labio-velars as contour-segments is that now another type of change, namely that between labials and velars receives a similar

account to that of palatalization in (8) above. It can be proposed that the acquisition of an U head is enough to get a plain labial from the unheaded labio-velar:

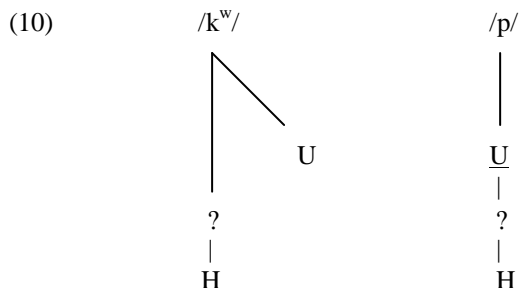

The above representation is remarkable for a number of reasons. If the representation for /f/ and /ɸ/ are compared, they differ solely in their headedness. The structures in (9) are asymmetric in this respect: /p/ is a straight structure, headed by U, while the labio-velar is a split structure without a head – they differ in two aspects, straight/unsplit and headed/headless. An interesting possibility would be to claim that the split structure is in some sense the counterpart of /p/. This is readily supported by labial–velar interactions in a number of languages: *eg* IE **ek^wos* → Ogam Irish *ech* /ex/, Lat *equus*; but Gaulish *epa-*; Welsh *ebol* ‘colt’, Gk *hippos*. If this claim can be sustained, then it could be further argued that the labio-velar also has a straight structure, just like /p/, the difference being that of headedness only:

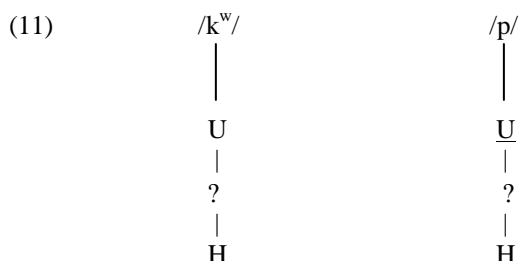

Merits (or demerits) of this claim are not further discussed here.

3. Element theories (2) – arriving at Backley’s geometrical tiers and tier activation

The (original) assumption of element theories that velars are headed by \cong makes some intriguing predictions about lenition phenomena involving velars, as pointed out by Szigetvári (1994:216). This revolves around the practice of head-switching with the possibility that \cong becomes the head in a consonant. Accordingly, the

following changes are no less likely to occur in natural languages than a switch in, say, [s] → [h]:

- | | | |
|----------|-------------------------|-----------------------|
| (12) (i) | [t] → [k] | {h (≅)} → {? h ≅} |
| (ii) | [p] → [k] | {? U h (≅)} → {? h ≅} |
| (iii) | [k ^w] → [p] | {? U h ≅} → {? U h ≅} |

While these changes are admittedly rare in their frequency, they still occur. According to Backley (1995), however, such head-switching operations violate the Structure Preservation Principle. Consider the following alternation between two vowels:

- (13) /e/= {I, A} → /E/= {I, A, ≅}

Backley convincingly argues that in the above structure any modification of the lexically given headship relations clearly violates the SPP. The headship account is problematic for other reasons as well. If, however, head-switching is illegitimate, then there seems to be little use for heads, too. This is exactly what Backley argues for: he dispenses with heads. This is at first sight much too strong a claim since on the empirical side at the same time there are still phenomena which could be captured quite effectively by heads and head-switching: an account for them is still desirable. His solution is tier geometry – this is the moment that phonological representations go 3D.

He has two assumptions, namely that

- (14) 1) all positions contain all melodic elements: full set of resonance elements present in all positions;
 2) a mechanism of tier-activation: melodic oppositions are expressed *through the activation of elements already resident in the structure*

In this view, as formulated in Backley and Takahashi (1998:27), “melodic oppositions are expressed not in terms of the presence or absence of particular elements, but via the *activation* of elements already resident in the structure.” In addition, to account for processes and alternations like in (12) or (13) he proposes the notion of a *complement tier* (Backley 1995:418): “...an active complement has the function of enhancing the saliency of a colour element by affording it ‘depth’, and not by inserting an additional plane into the melodic representation.” Further, “[i]t should be noted, however, that the relationship between the colour tier and its complement is not identical to that existing between the colour tier and the [A]-tier. In the former association there is no new elemental material added to the structure when the complement is activated; instead, the same plane is merely expanded in another direction.” Their system is in essence a reconfiguration of the headed/headless distinction in a structurally dynamic way (Backley and Takahashi, 1998: 27).

Backley and Takahashi (1998:26,38) introduce element activation, a mechanism which they define as follows:

- (15) Activate[α]
- (i) [α] contributes to overall interpretation *iff* active;
 - (ii) it is a lexical instruction which specifies the melodic material that may be potentially interpreted in the phonological string;
 - (iii) a specific domain of activation is an integral part of the lexical instruction itself

The functioning of such an activation mechanism is described as follows (Backley and Takahashi, 1998:29-30): “the melodic properties of a morpheme (which are, of course, idiosyncratic) are specified in terms of a series of activation “operations” occurring at different points throughout the length of the phonological string. So, the vowel in the English word *foot* is represented in the lexicon by the single instruction ACTIVATE (U). On the other hand, a melodically complex expression such as a front mid vowel, is encoded lexically by means of (at least) two simultaneous activation instructions – ACTIVATE (I) and ACTIVATE (A).”

If these operations are translated to the velars at hand, then they can be said to lack such an activation instruction for any melodic element (though they might have such an instruction for stopness, friction, *etc*). However, it is also clear that in the case of various velar developments, there is an intimate relationship between activation and certain other mechanisms, namely government and licensing. For instance, loss of velars is argued here to be the result of their I/U-tier being unlicensed, when they cannot activate further tiers, namely the ?- and H-tiers. Furthermore, reductions to velars are cases where elements are consecutively suppressed (not activated) through government. Velar palatalizations on the other hand are argued to be cases where under licensing an activation instruction (of the I-tier) is executed. The nature of the interaction between activation and the other two forces is far from being unproblematic or clear even in broad terms. This is an area for ongoing research, however, results are indeed coming up.

This is then the proposed expression of velar segments (with the status of H/h unsettled; with the complement U in /p/ only typographically coming next to [?!]):

(16)	/⊗/	/g/	/x/	/k/	/k ^h /	/k ^w /	/p/
	x	x	x	x	x	x \	x
I/U tier							
	[]	[]	[]	[]	[]	[] [U]	[U]
?-tier	[]	[?]	[]	[?]	[?]	[?]	[U]
H-tier	[]	[H]	[H]	[H]	[H]	[H]	[H]

[H]

Some remarks are in order in connection with the structures above. Firstly, melodic tiers are assumed all through because melodic tiers are present in each timing slot in this approach and velars can indeed potentially refer to this particular tier only, when the tier gets activated. Secondly, whether a [COMP] should also be postulated on the I/U tier is still to be seen. Thirdly, an intimate relationship between activation and licensing has already been referred to. Some possible interactions are given below:

- (17) interaction of government, licensing and activation
no interaction btw [⊗] and [?] no ?-tier needed in /⊗/
/g/ -> /⊗/; /k/ -> /x/; /p/ -> /f/ Government hits (=destroys??) ?-tier
first in C's
/k/ -> (/x/) -> /j/ Government then hits (=destroys??)
“friction”
/⊗/ -> /j/; /⊗/ -> /w/ ACTIVATE [I], ACTIVATE [U],
respectively
(all these occur in licensed positions)
/p/ -> /x/ in non-licensed position, governed

The following are sample representations for some velar phenomena. They are simply meant to serve an illustrative function in the first place, while bringing out some key features of the theories combined.

(18) velar palatalization

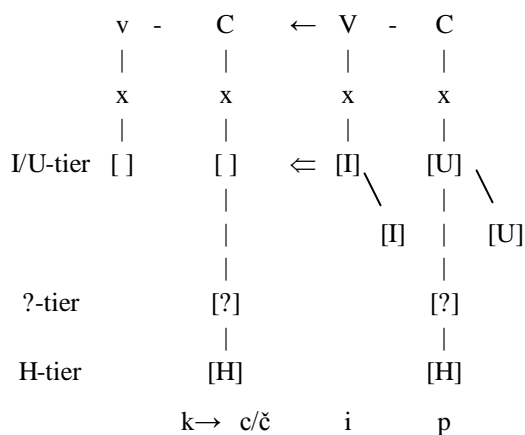

(19) Vocalization to /j/ - activation of I
dΘg – present day English ‘day’

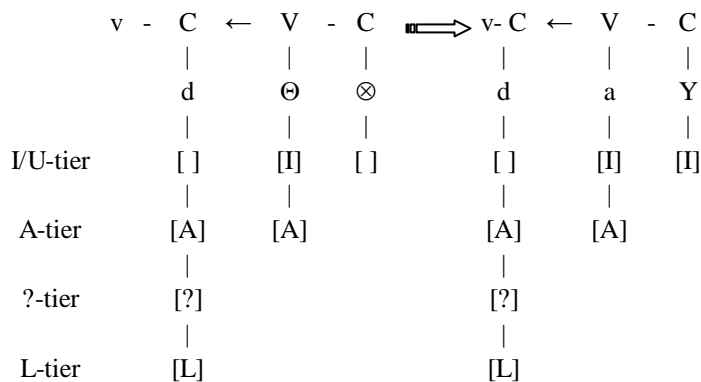

4. Conclusions

In this paper the relationship between velars and empty-headed segments has been considered and it has been shown that velars can perfectly do without any recourse to any specific place of articulation in their phonological behaviour. In other words, velars lack a phonologically relevant place of articulation, and no

phonological rules can refer to such a place either. The first indications to this effect come from as early as traditional generative approaches with binary distinctive features, where velars fell out, so to speak, to be negatively specified for [coronal] and [labial]. In element approaches to melodic composition, velars can be rightfully argued to be the consonantal counterpart of empty-headed vowels. Further, it has been shown that headedness and heads in general can be dispensed with in favour of a more constrained mechanism, namely element activation. What is of crucial significance is that velar phenomena can be effectively captured in such a framework as well. The relations between element activation and the well-known (but probably little understood) government theoretical devices, government and licensing, are still wanting clarification.

References

- Backley, P. (1995) 'A tier geometry for vowels', *UCL Working Papers in Linguistics* 7: 399-436.
- Backley, P. and T. Takahashi (1998) 'Element activation', in: Cyran (1998): 13-40.
- Charette, M. (1992), 'Mongolian and Polish meet Government Licensing', *SOAS Working Papers in Linguistics and Phonetics* 2: 275-292.
- Cyran, E. (1997), *Resonance Elements in Phonology – A Study in Munster Irish*, PASE Studies and Monographs, Vol. 3, Lublin.
- Cyran, E. (ed.) (1998) *Structure and Interpretation – Studies in Phonology*. PASE Studies and Monographs, Vol. 4, Lublin.
- Dienes, P. and P. Szigetvári (1999), *Repartitioning the skeleton: VC phonology*, ms. ELTE, Budapest.
- Durand, J. (1990), *Generative and Non-Linear Phonology*, Harlow: Longman.
- Durand, J. and F. Katamba (eds) (1995), *Frontiers of Phonology: Atoms, structures, derivations*, Harlow: Longman.
- Harris, J. and G. Lindsey (1995), 'The elements of phonological representations', in: *Durand and Katamba* (eds.) (1995): 34-79.
- Harris, J. (1997), 'Licensing Inheritance: an integrated theory of neutralization' *Phonology* 14: 315-370.
- Huber, D. (2002) *Velar phenomena: processes and their expression in phonology*. MA Thesis, Budapest, ELTE.
- Kaye, J., J. Lowenstamm and J-R. Vergnaud (1990), 'Constituent structure and government in phonology', *Phonology* 7:193-231.
- Scheer, T. (1998), 'A theory of consonantal interaction', *Folia Linguistica* XXXII/3-4:201-237.
- Szigetvári, P. (1994), 'Coronality, velarity and why they are special'. in: *The Even Yearbook* 1994: 185-224, ELTE, Budapest.